

**FIMBEL**  
ARCHITECTURAL DOORS

*More in a Garage Door Since 1924.*

*More in a*  
**GARAGE DOOR**



PROUDLY MADE IN THE USA FOR OVER 95 YEARS BY THE FIMBEL FAMILY OF WHITEHOUSE, NJ  
FIMBELADS.COM

*Featured cover photo product details:*  
RT11S w/ Beadboard, custom arches and decorative hardware



**FIMBEL**  
ARCHITECTURAL DOORS  
More in a Garage Door Since 1924

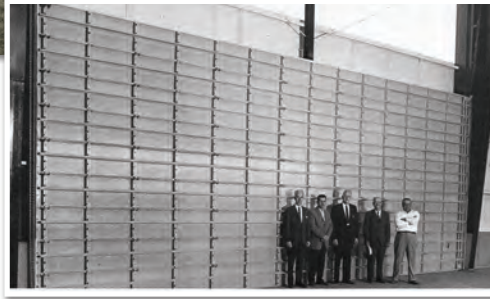

# FIMBEL

## Four Generations *of Quality Door* Manufacturers

With almost 100 years of manufacturing and engineering excellence, our four-generation family business has been a recognized leader and innovator in the garage door industry. Since our humble beginnings in Hillside, NJ, when we started producing doors for The Overhead Door Company, to our state-of-the-art manufacturing facilities today, Fimbel Architectural Door has earned a reputation for quality and design excellence.

Whether your needs are residential or commercial, carriage style or modern design, historic restoration or new application, we can create the perfect garage door experience for you. We will design and build your door using low-maintenance, energy-efficient materials, manufactured in a sustainable way.

We look forward to our family working with your family to create something *truly special*.

# Why every Fimbel Door is truly *Greater* than the rest

## ⚙️ PROCESS:

- Each door is crafted with care and uniquely engineered and manufactured to our strict specifications
- Precise details are controlled through proven and sustainable state-of-the-art systems built on quality to ensure repeatability and longevity
- Quality systems and manufacturing practices are systematically challenged and enhanced through continuous improvement processes

## 👥 PEOPLE:

- We are proudly owned and operated by the fourth generation Fimbel family
- We graciously recognize that safety and quality begin with each one of our team members
- We choose to work with partners that share our values and ambitions for quality, safety and customer satisfaction

## 🏆 PRODUCT:

- Multiple design patents deliver a wide-range of unique styles and price points
- Exceptional warranty – we stand behind our product
- Engineered and crafted for longevity, durability and beauty
- Premium features and custom options available for design, finish, application and beyond
- We are 100% American-made

## ❤️ COMMUNITY:

- Our "family" extends to our team, partners, community and customers; we are who we are today because of them
- We take pride in partnering with local businesses and supporting community first responders and are proud to be the sole supplier of overhead doors to the New York City Fire Department
- We are excited to engage the youth in our community by supporting local sports teams and vocational schools
- 23 dogs fostered by the Fimbel Team!

# Milestones in Fimbel History



1924

It begins in 1924 with a master carpenter, **Edward Fimbel Sr.**, signing the first franchise with **The Overhead Door Corporation** to manufacture, distribute, and install wood sectional garage doors in the northeastern region of the US. A dream to bring forth more begins.



1946

**Edward Fimbel Jr.**, a mechanical engineer, begins his life-long career in the garage door industry after serving in the U.S. Navy during World War II. The business and family continue their expansion and innovation.



1950

**Paul Fimbel**, Ed Fimbel Sr.'s eldest son, opens a new 60,000 square foot New Hampshire-based manufacturing facility which would operate over the next 50 years.



1967

Opening a new 140,000 square foot factory in Whitehouse, NJ, the newly organized and renamed company, Fimbel Door Corporation (FDC) commences production of wood, aluminum, steel and fiberglass doors.

**Edward Fimbel III** joins FDC as sales manager.



1984

After shaping an industry, Edward Fimbel Sr. passes at the age of 94, passing his lessons and his legacy to **Edward Fimbel Jr.** who becomes president of FDC.



1988

Fimbel opens their new McAdoo, PA manufacturing plant to produce Powerlift® Residential Garage Door Openers.



1991

Fimbel acquires and sets up an automated roll forming line to manufacture foamed-in-place residential and commercial insulated steel doors at their Whitehouse, NJ factory.



2004

**Edward III** launches **Fimbel Architectural Door Specialties (FADS)** in Whitehouse, NJ to turn the garage door from ordinary to extraordinary while maintaining the family legacy.



2014

**Erin Fimbel Heindrichs**, Edward Fimbel III's daughter, becomes president of FADS, beginning the fourth generation of Fimbel leadership. In this role, she launches "Operation Excellence" (a continuous improvement program) to drive benchmark performance in quality and customer service.



TODAY

The Fimbel family has manufactured garage doors for more than nine decades, making it the world's oldest manufacturer of sectional garage doors still owned and operated by the founding family.



# Explore *More* in Our Garage Doors

There's a Fimbel door for every budget and every home



PAGE 5:  
**Green Manufacturing**



PAGE 14:  
**Presidential Series**  
*Estate Collection*

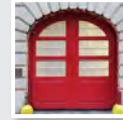

PAGE 21:  
**Custom Firehouse**  
**Collection**



PAGE 27:  
**Additional**  
**Door Add-ons**



PAGE 6:  
**How to Choose**  
**a Garage Door**



PAGE 16:  
**Roaring Twenties**  
**Series**  
*Estate Collection*



PAGE 22:  
**Case Studies**



PAGE 28:  
**Glazed Grille**  
**Top Options**

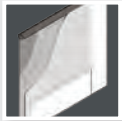

PAGE 8:  
**Fimbel Platforms**



PAGE 18:  
**Custom Doors**  
*Residential & Commercial*



PAGE 24:  
**Finishing Options**



PAGE 29:  
**Warranty**



PAGE 10:  
**American Legends**  
**Collection**



PAGE 19:  
**Custom Doors**  
*Tops & Designs*

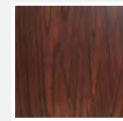

PAGE 25:  
**Faux Stain Samples**

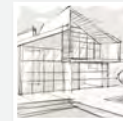

PAGE 30:  
**For Architects**



PAGE 12:  
**Euro-Dor Series**  
*Estate Collection*

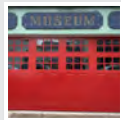

PAGE 20:  
**Custom Doors**  
*Modern & Historic*



PAGE 26:  
**Specialty Glass**  
**Options**



PAGE 31:  
**Building**  
**Materials**

## *Fimbel Certifications, Partnerships, Associations & Recognition*



# SUSTAINABILITY

## Fimbel Doors are built to last

Eco-friendly garage doors minimize their impact on the environment, both during their construction and throughout their lifetimes.



Our focus is all about **Quality and Safety**. These two measures are applied not only to the products we manufacture, but also to the processes and people involved. Our priorities are clear: supporting the environment, our global and local community, our team members, and our Partners. Each one drives us to succeed for the benefit of all. We know

we cannot change the world with only a door, but we can challenge how we operate to improve efficiency, reduce supply-chain demand, retain and empower our team, and build stronger communities. Our quality allows us to get it right the first time, reducing the undue impact to all. Our goal is to pave the way for the next generation.



## Tough & Environmentally Friendly

*Engineered for Optimal Value & Longevity*

### MANUFACTURING PROCESS:

- **Energy Smart** – *Built to Endure and to Save:*
  - Honest and verified R-Values\* ranging from 8-13
  - Quality insulation to reduce negative energy consumption
  - Windload available, built to withstand extreme winds. Safer community by enhancing the stability of the garage
- **Low Maintenance** – *Less Stress:*
  - Made to be naturally unfinished and virtually maintenance-free
  - Finished product utilizes water-based and eco-friendly paints

- **Internal Efficiencies Drive Less to the Landfill:**
  - Conservation of resources
  - Annual goal to reduce scrap year-after-year
  - All scrap is filtered for reuse in product

### OPERATIONS:

- We run on SOLAR! And we pass along our unused power back to the grid
- Recycling Program:
  - Reduce single-use plastics
  - Conservation of office paper and supplies
  - Utilizing recycled paper and compostable products
- Internal focus on optimization of logistics to reduce our footprint
- Packaging improvements to reduce waste and damage
- Recycled paper in all offices

### ONE TREE PLANTED:

- “The best time to plant a tree was twenty years ago. The second-best time is now.” – Darrell Putman
- We partner with One Tree Planted (501c3) to do our part to restore our generous forests and our planet
- Together, we hope to make the world more beautiful and long-lasting one door and one tree at a time

\* Measures the thermal resistance to heat flow of a product. (i.e. R-8 = 90% amount of heat-flow reduction)



**FIMBEL**  
ARCHITECTURAL DOORS  
More in a Garage Door Since 1924.

# How To *Choose* a Garage Door

Important considerations to find the right door for your home with confidence

## Benefits of A NEW Garage Door



**94.5%**  
ROI at resale

**71%**  
of Americans use their garage door as the primary entrance to the home

**30%**  
of a home's frontage can be the garage door(s)



1

## What's Behind the Door?



How do you want to use your garage?

- ▶ Primary entrance to the home
- ▶ Active living (snow-mobiles, ATVs, golf carts, boats)
- ▶ Car lifts
- ▶ Home gym
- ▶ Living space: man-cave or she-shed
- ▶ Active or growing family
- ▶ Workspace



2

## Determine Your Budget



Having a budget helps your installer guide recommendations.

Expect to pay more for:

- ▶ Double doors or custom sizes
- ▶ Curb appeal and customized options
- ▶ Higher quality, low-maintenance materials
- ▶ Stain and paint options
- ▶ Insulated glass upgrade for insulated or heated garages



3

## Pick Your Garage Door Material

(FOR RESIDENTIAL APPLICATIONS)

Your material will impact budget, appearance/style options, longevity, durability and annual maintenance.

- ▶ **VINYL:**  
BEST ★★★★★  
Offers beauty, durability and design flexibility with the look of wood but is weather-resistant, so it will not rot, split or crack like wood. It is virtually maintenance-free. Comes naturally white.
- ▶ **WOOD COMPOSITE:**  
BETTER ★★★★★☆  
Has the look and design flexibility of wood or vinyl, but unlike wood, it does not require maintenance. Requires initial finishing but can be painted or faux stained regardless of environment or exposure. Will not rot, split, crack, rust or dent.
- ▶ **VINYL-COATED STEEL:**  
BETTER ★★★★★☆  
Smooth, natural white finish offers exceptional beauty and options for paint or faux stain finishing. Budget-friendly with many of the benefits of vinyl and steel combined: weather-resistant, durable, dent-resistant, will not rot, split, crack or rust.
- ▶ **ALUMINUM:**  
BETTER ★★★★★☆  
Limited design capabilities, but comes finish-painted or faux-stained. Subject to denting but will not rot, split or crack like wood, will not rust like steel.
- ▶ **WOOD:**  
GOOD ★★★★★☆  
Beautiful when new but requires ongoing maintenance to remain in good condition and to avoid rotting, splitting or cracking. Can be painted or stained and provides many design options. Wood doors are the original overhead door.
- ▶ **STAMPED STEEL:**  
GOOD ★★★★★☆  
A lower-cost alternative but does not have the curb appeal of other options. Limited style options. Little to no maintenance required but is prone to corrosion and denting, leading to a shorter life-cycle. Can be finished.

## Consider the **LONGEVITY** of your garage door

### Required Maintenance

Ask about required routine maintenance to ensure it meets your lifestyle and budgetary needs

### Plan for Longevity

Ask if replacement parts are available or if the entire door needs to be replaced if ever damaged

### Lifecycle

Ask about the product's typical lifecycle

### Warranty

Ask about the product warranty to ensure that it meets your expectations and needs

4

## Overcome Environmental Considerations

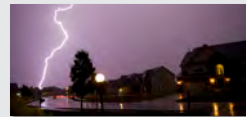

Do you live in an area where you could benefit from energy-efficient products that will withstand the test of time and natural elements?

	Vinyl	Wood Composite	Vinyl Coated Steel	Aluminum	Wood	Stamped Steel
Coastal & Waterfront	✓	✓	✓	✓		
Heavy Sun Exposure*	✓	✓	✓	✓		✓
High Humidity	✓	✓	✓	✓		
Snow & Road Salt	✓	✓	✓			
High Winds**	✓	✓	✓	✓	✓	✓

\* Cannot be painted or stained dark colors in heavy sun exposure

\*\* Be sure to understand local codes and ask about a wind load-certified door



**R-VALUE DEFINED:** Used to represent energy efficiency.

- R-8 = 90% amount of heat-flow reduction
- R-12 = 93% amount of heat-flow reduction
- R-16 = 95% of heat-flow reduction

5

## Choose Your Design and Options

Consider your home style, color and features like entry doors, windows, arches, angles and profiles.



### Top Section

- Solid or Glass
- Glass Windows (pg. 26):
  - Configuration
  - Shape/design
  - Square or arch
  - Scrollwork or words



### Solid Sections

- Choose a model
- Profile designs (pg. 8)
- Custom designs (pg. 18)

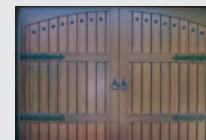

### Exterior Options

- Factory finish (pg. 24)
- Specialized Glass (pg. 26)
- Decorative hardware (pg. 27)



### Interior Options (pg. 28)

- Powder coated hardware
- Finished interior
- Custom track set ups
- Finished TDL on interior

6

## Door Finishing Options

### ▶ NATURAL

- No upkeep such as repainting or re-staining
- Some materials require finishing



### ▶ PAINTED

- Factory
- D-I-Y
- Custom colors
- No upkeep



### ▶ STAINED

- Faux-Wood stain look without maintenance



### ▶ POWDER COATING

- Add a wow factor to your garage interior and consider powder coating your track and hardware!

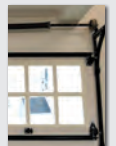



**FIMBEL**  
ARCHITECTURAL DOORS  
More in a Garage Door Since 1924

# Build a Fimbel Garage Door, Your Way...

## ALL FIMBEL PRODUCTS:

- ▶ Uniquely crafted for you (customizations starting on pg. 18)
- ▶ Smooth, high-end look of wood
- ▶ Low-maintenance
- ▶ Replacement sections available
- ▶ Range of styles and price points

- ▶ Solid, one-piece grille with no joints or inserts and profile options
- ▶ Large or small window options
- ▶ Available in 1" height increments
- ▶ Custom designs and arches available

- ▶ Energy-efficient
- ▶ Multiple design patents
- ▶ Quality finishing options
- ▶ American made
- ▶ Robust long-life warranty regardless of geography

▶ Learn more about our products:  
[www.fimbelads.com/door-ology](http://www.fimbelads.com/door-ology)

## ▶ THE AMERICAN LEGENDS SERIES:

### Vinyl-Coated Steel



Built using advanced materials, every American Legends door delivers incredible style, lasting beauty and a terrific return-on-investment. With head-turning curb appeal, they provide extraordinary beauty and require very low maintenance.

- ▶ Showcased on pages 9 - 10
- ▶ See more at [www.fimbelads.com/gallery](http://www.fimbelads.com/gallery)

### The American Legends Series Features:

1. Vinyl-coated steel for smooth beauty and durability
2. Fully-insulated for efficiency, noise control and value
3. Smooth, solid overlays
4. Vinyl interior cover
5. Four sections (standard) with customizable height and top options
6. The smooth look of painted wood
7. Robust warranty regardless of geography
8. Vast finishing options





# ...From Two Standard Platforms.

## ➤ THE ESTATE COLLECTION: \$\$\$\$ - \$\$\$\$ \$

Vinyl and Wood Composite Materials



This patented innovation offers designs to bring Old-World craftsmanship and unmatched beauty to any home or building. Manufactured from advanced materials that require very low-maintenance and provide enduring good looks, our doors offer innovation and inspiration to bring your designs to life.

- ▶ Showcased on pages 13 - 17
- ▶ See more at [www.fimbelads.com/gallery](http://www.fimbelads.com/gallery)

### The Estate Collection Features:

1. Insulated core:
  - a. Wood frame
  - b. Impenetrable surrounds to seal out the elements
2. Single smooth sheet creates a blank canvas for your design
3. Fully-laminated back cover (optional composite interior backer pg. 27)
4. 3 sections (standard) with customizable height, width and top options (optional interior grille pg. 27)
5. Fully-customizable solid sections and glass sections
6. Architectural profiles available (see series pages)
7. Robust warranty regardless of geography

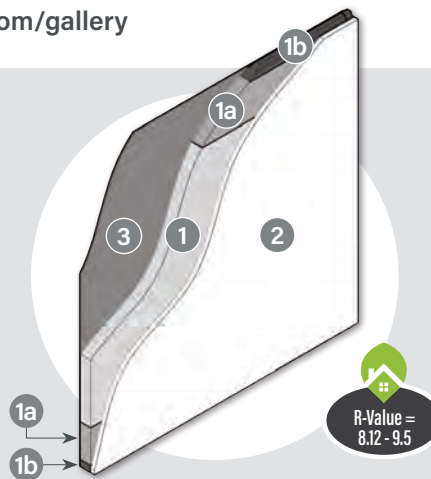

### Estate Door Profiles:

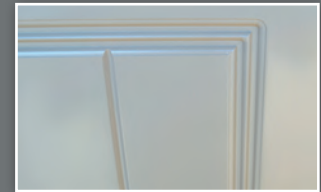

EURO-DOR DETAIL

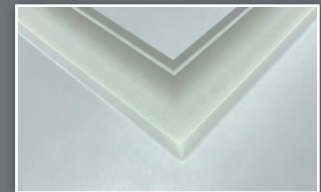

PRESIDENTIAL DOOR DETAIL



ROARING TWENTIES DOOR DETAIL

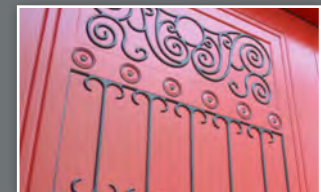

CUSTOM DOOR DETAIL



EURO-DOR EXAMPLE



PRESIDENTIAL DOOR EXAMPLE



ROARING TWENTIES DOOR EXAMPLE



CUSTOM DOOR EXAMPLE



**FIMBEL**  
ARCHITECTURAL DOORS  
More in a Garage Door Since 1924.

# The American Legends Series

## *Carriage House Style*



LV13S w/ 12 lites

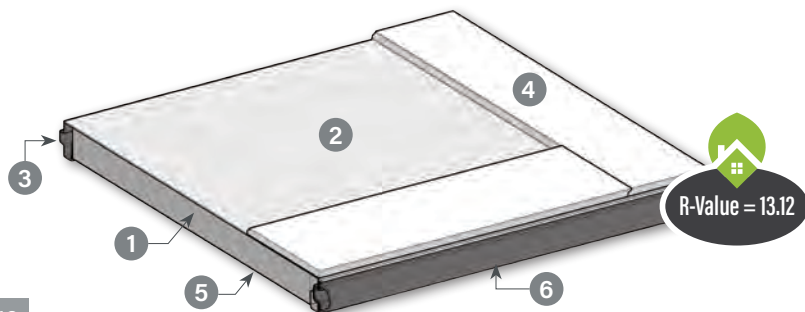

### American Legends Series Innovative Construction Features:

1. Laminated, insulated core to increase energy efficiency and reduce noise
2. Vinyl-coated smooth 20 gauge face
3. Interlocking tongue and groove vinyl-coated sections joints to tightly secure your garage
4. Cope & Bead smooth, solid composite overlays
5. High-impact prefinished interior cover to protect your door
6. Heavy-duty bottom astragal to protect the interior of your garage
7. The look of real painted wood
8. Traditional style grille (see page 28)
9. Standard glass section profile: C-Grille (see page 28)
10. Standard: 4 sections with customizable tops
11. Overall section thickness is 2.5"

*Experience More...* MORE CREATIVITY. MORE BEAUTY. MORE DURABILITY.



**American Legends Series**

**MODELS AND SPECIFICATIONS**

To view our complete catalog of available models and product specifications, go to: [www.fimbelads.com/american-legends](http://www.fimbelads.com/american-legends)

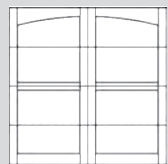

LV11-A Bell

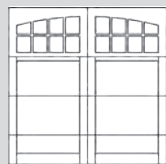

LV11-A Edison

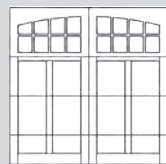

LV12-A Ford

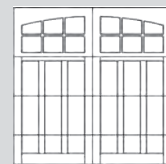

LV13-A Lindbergh

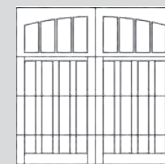

LV14-A Franklin

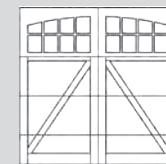

LV15-A McCormick

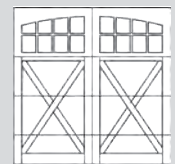

LV15-A Revere



LV11-A Carver



LV11-S Ross

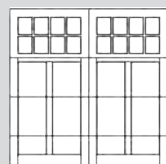

LV12-S Vanderbilt

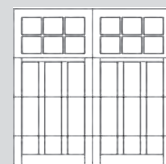

LV13-S Wright



LV14-S Armstrong



LV15-S Oakley

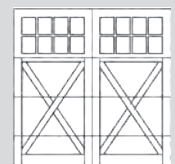

LV17-S Hancock



**FIMBEL**  
ARCHITECTURAL DOORS  
More in a Garage Door Since 1924

# Euro-Dor | Carriage House Style

PART OF THE ESTATE COLLECTION

EU504 w/ v-grooves and faux stain

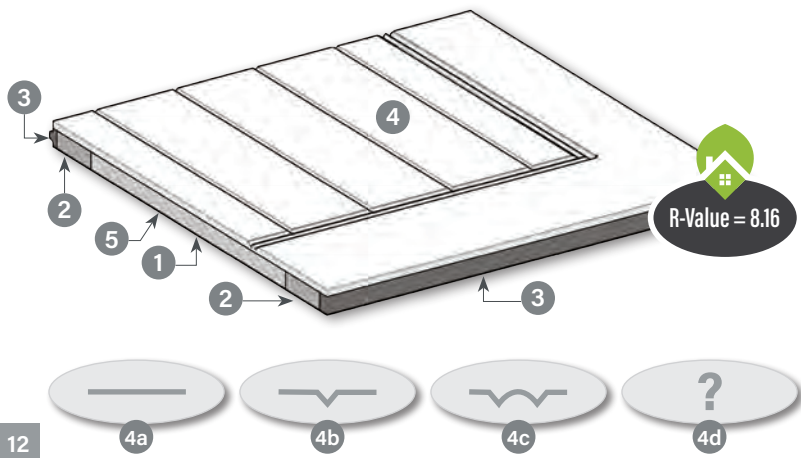

## Euro-Dor Innovative Construction Features:

- Laminated, insulated core to increase energy efficiency and reduce noise
  - 4a. Smooth
  - 4b. V-Groove (shown here)
  - 4c. Beadboard
  - 4d. Custom designs
- Heavy-duty wood frame at all fastening points
- Impenetrable composite surrounds create the interlocking tongue and groove to seal out the elements and increase sustainability
- Precision-machined architectural relief in solid  $\frac{3}{8}$ " high impact composite face
- High-impact prefinished interior cover to protect your door (optional composite interior backer pg. 27)
- Fully-customizable designs for solid sections and glass sections
- Euro-style grille (pg. 28) with optional interior grille (pg. 27)
- Standard glass section profile: C-Grille (see pg. 28)
- Standard: 3 sections with customizable height, width and top options
- Overall section thickness is  $1\frac{7}{16}$ "
- Slab doors available (consult dealer)

*Experience More...* MORE CREATIVITY. MORE BEAUTY. MORE DURABILITY.

**BEFORE REPLACEMENT**



**AFTER = MORE IN A GARAGE DOOR!**



**Euro-Dor  
Door Style**

**MODELS AND  
SPECIFICATIONS**

To view our complete catalog of available models and product specifications, go to: [www.fimbelads.com/euro-dor](http://www.fimbelads.com/euro-dor)

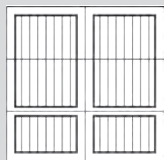

Stockholm EU-500

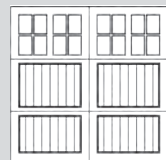

Florence EU-502

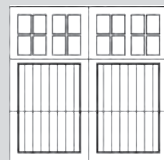

Brussels EU-504

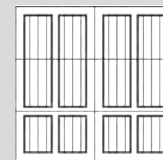

Geneva EU-506

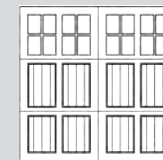

Amsterdam EU-508



Dublin EU-510

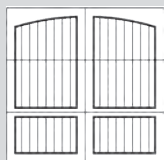

Luxembourg EU-501



Milan EU-503



Athens EU-505

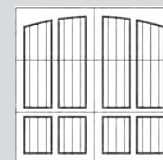

Edinburgh EU-507

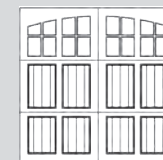

Barcelona EU-509



Madrid EU-511



**FIMBEL**  
ARCHITECTURAL DOORS  
More in a Garage Door Since 1924

# Presidential Door

# *Carriage House Style*

PART OF THE ESTATE COLLECTION



PR12S w/smooth face, custom lites, and faux stain

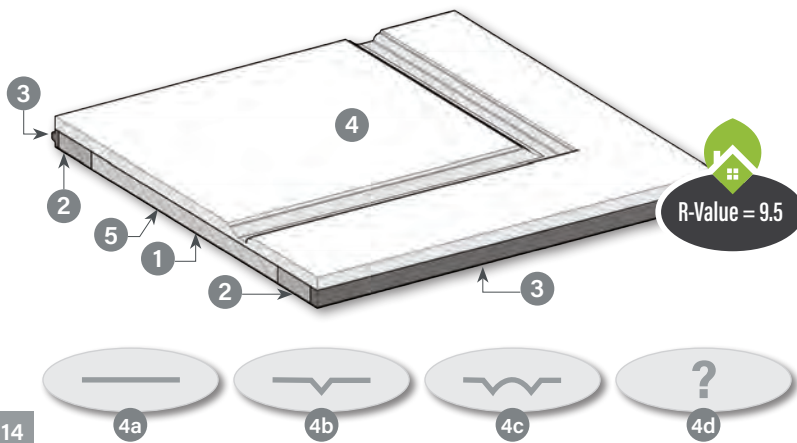

## Presidential Innovative Construction Features:

- Laminated, insulated core to increase energy efficiency and reduce noise
- Heavy-duty wood frame at all fastening points
- Impenetrable composite surrounds create the interlocking tongue and groove to seal out the elements and increase sustainability
- Precision-machined architectural relief in solid  $\frac{3}{4}$ " high impact composite face
  - 4a. Smooth
  - 4b. V-Groove (shown here)
  - 4c. Beadboard
  - 4d. Custom designs
- High-impact prefinished interior cover to protect your door (optional composite interior backer pg. 27)
- Fully-customizable designs for solid sections and glass sections
- Traditional style grille (pg. 28) with optional interior grille (pg. 27)
- Standard glass section profile: C-Grille (see pg. 28)
- Standard: 3 sections with customizable height, width and top options
- Overall section thickness is 1  $\frac{3}{4}$ "
- Slab doors available (consult dealer)

*Experience More...* MORE CREATIVITY. MORE BEAUTY. MORE DURABILITY.



**Presidential  
Door Style**

**MODELS AND  
SPECIFICATIONS**

To view our complete catalog of available models and product specifications, go to: [www.fimbelads.com/presidential](http://www.fimbelads.com/presidential)

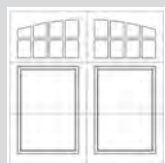

Washington PR11-A



Jefferson PR12-A

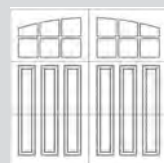

Roosevelt PR13-A

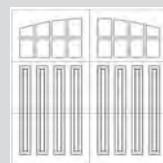

Monroe PR14-A

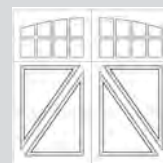

Eisenhower PR15-A

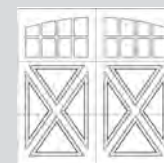

Grant PR17-A

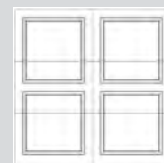

Taft PR11-S

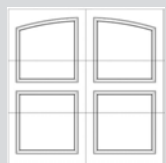

Jackson PR11-A

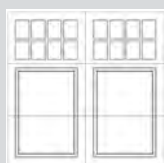

Adams PR11-S



Lincoln PR12-S

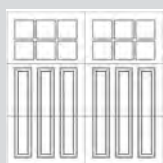

Harrison PR13-S

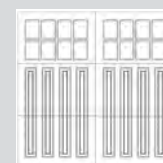

McKinley PR14-S

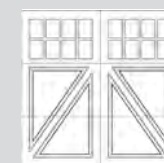

Coolidge PR15-S

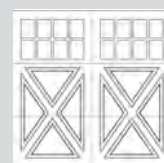

Madison PR17-S



**FIMBEL**  
ARCHITECTURAL DOORS  
More in a Garage Door Since 1924.

# Roaring Twenties

# Carriage House Style

PART OF THE ESTATE COLLECTION



RT11A w/decorative hardware and Cashmere factory finish

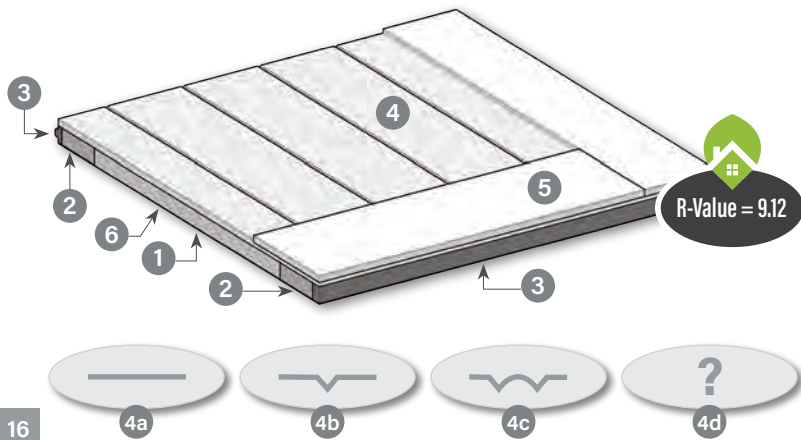

## Roaring Twenties Innovative Construction Features:

- Laminated, insulated core to increase energy efficiency and reduce noise
- Heavy-duty wood frame at all fastening points
- Impenetrable composite surrounds create the interlocking tongue and groove to seal out the elements and increase sustainability
- Precision-machined architectural relief in solid  $\frac{3}{8}$ " high-impact composite face
  - 4a. Smooth
  - 4b. V-Groove (shown here)
  - 4c. Beadboard
  - 4d. Custom designs
- Square edged smooth, solid composite  $\frac{1}{2}$ " overlays are inlaid (pocketed) for durability
- Prefinished interior cover to protect your door (optional composite interior backer pg. 27)
- Fully-customizable designs for solid sections and glass sections
- Traditional style grille (pg. 28) with optional interior grille (pg. 27)
- Standard glass section profile: V-Grille (see pg. 28)
- Standard: 3 sections with customizable height, width, and top options
- Overall section thickness is  $1\frac{13}{16}$ "
- Slab doors available (consult dealer)



*Experience More...* MORE CREATIVITY. MORE BEAUTY. MORE DURABILITY.

**BEFORE REPLACEMENT**



**AFTER = MORE IN A GARAGE DOOR!**



**Roaring Twenties  
Door Style**

**MODELS AND  
SPECIFICATIONS**

To view our complete catalog of available models and product specifications, go to: [www.fimbelads.com/roaring-twenties](http://www.fimbelads.com/roaring-twenties)

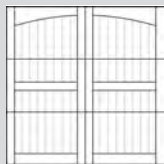

St. Louis RT11-A

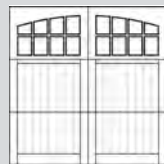

Hartford RT11-A

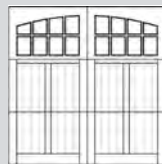

Yonkers RT12-A

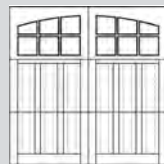

Chicago RT13-A

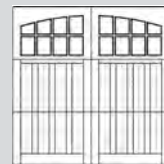

New Yorker RT14-A

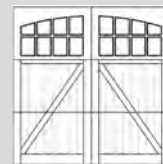

Patterson RT15-A

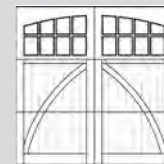

Philadelphia RT16-A

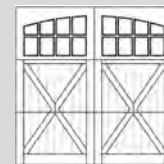

Norfolk RT17-A

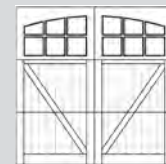

Providence RT18-A

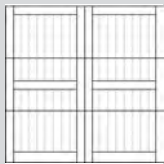

Richmond RT11-S

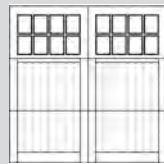

Detroit RT11-S

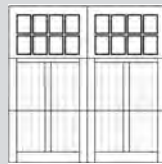

Charleston RT12-S

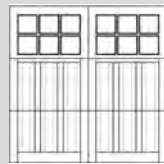

Newark RT13-S

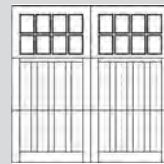

Baltimore RT14-S

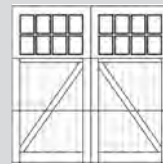

Harlem RT15-S

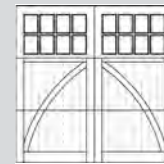

Cincinnati RT16-S

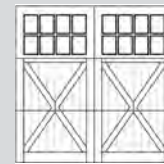

Boston RT17-S

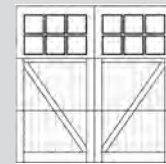

Bridgeport RT18-S



**FIMBEL**  
ARCHITECTURAL DOORS  
More in a Garage Door Since 1924

# Custom Doors | *Residential & Commercial*



Custom Presidential with clavos and bronze factory finish

## *You Dream it. We Build it.*

**We have the solution for you.** We offer everything from creative designs, funky features to matching uneven floors and odd heights and widths. Whether it is aligning with the requests of the local historical society, fulfilling a technical or design challenge, or simply satisfying a whim, we are enthusiastic about taking on your vision and building to your one-of-a-kind requirements! ***The following pages will walk you through some capabilities, but we encourage you to think big and think beyond what you see.***



## CUSTOM DOOR TOPS

*Varied window sizes, arches, configurations, designs and more!*



Scroll Grille



Colonial Corner



Double Grilles



Custom Lites



Interior Grille Insert

## CUSTOM DOOR DESIGNS

*Nearly endless design options carved into a single sheet: profiles, symbols, designs, logos, etc.*



Engravable Designs

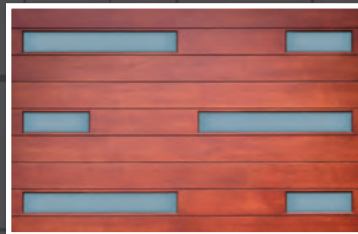

Varied Window Placement



Unique Designs



Flood Vents



Logos and Branding



### ***Bring your door to life:***

- Customized hardware packages
- Powder coated hardware packages
- Interior Options: Thickness & Finishing
- Decorative Hardware



### ***Complement the architecture of your home:***

- Fascia and Soffits
- Pergolas & Cupolas
- Historic Preservation
- Fence Accents and Arbors
- Decorative Accents
- Custom Window Designs

**WHEN IT COMES TO CUSTOM DOORS, WE HAVE YOU COVERED.**

From Residential to Commercial and Historic to Contemporary, we work with designers, architects, builders and homeowners to do more than simply close an opening. Reach out to our friendly team at [sales@fimbelads.com](mailto:sales@fimbelads.com) and find MORE at [www.fimbelads.com](http://www.fimbelads.com). *We look forward to bringing your dream to life!*



**FIMBEL**  
ARCHITECTURAL DOORS  
More in a Garage Door Since 1924.

# Custom Doors | *Modern & Historic Styles*

## CUSTOM MODERN DOORS



### ▶ PLANK DOOR:

- Using innovative technology and our hand-crafted frame, we added windows to the customer's specifications, completing the look with custom satin deco glass and a custom stain. Modern design at its finest. Quality to last.

### ▶ PALLET DOOR:

- Built to marry a rugged and durable look with elegance in the design and materials. The hand-applied faux stain completes the look. With options from the glass to the window spacing to the color of the stain, this door has it all!

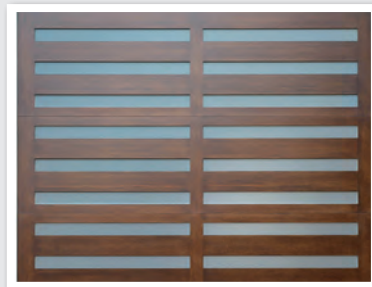

### ▶ FLUSH:

- From traditional to contemporary, flush doors with a smooth, clean look can simply complete the look or allow for custom cladding.

## CUSTOM HISTORIC DOORS



### ▶ CUSTOM ARCH ON CARRIAGE HOUSE:

- Complementing the timeless design of the architecture, the custom arches create a cozy and welcome look to replicate the original carriage house doors. The look of wood and the appearance of true-divided lites completes the historic appeal.

### ▶ TWO DOORS IN ONE:

- The existing doors were designed for carriages, and today's vehicles no longer fit. To meet the demands of the historic society on this project, a faux center post was added to a double door to replicate the look of two single doors in one. Add the custom color of Essex Green, and the project is complete.



### ▶ HAZLETON MUSEUM:

- This Museum is housed in the historic Pioneer Fire Co. building, which once served as Hazleton's borough hall. The custom door and entry door welcomes visitors to the quiet hills of Pennsylvania for a trip down memory lane.



# Custom Doors | *Firehouse Collection*

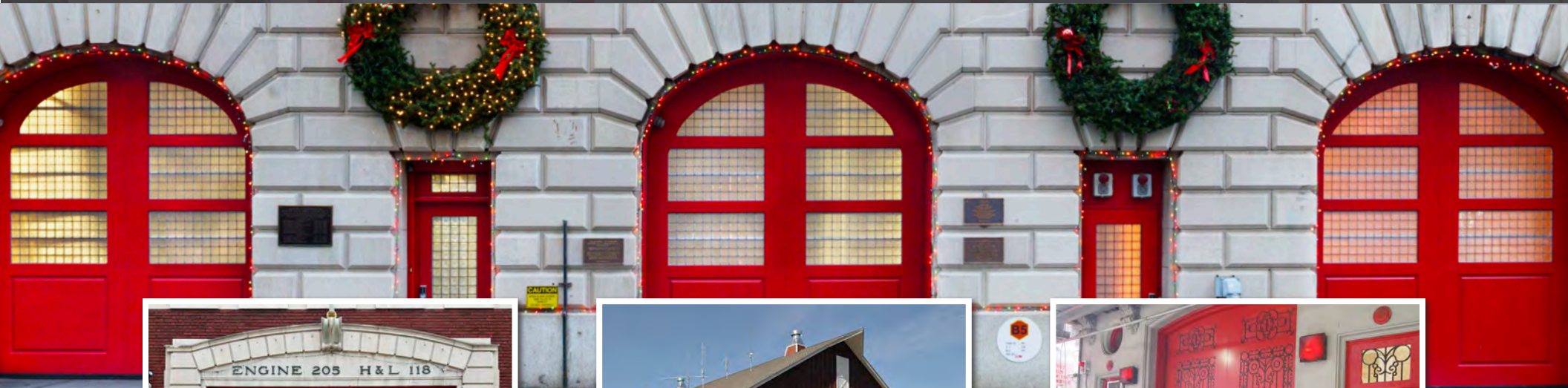

## **ENG 205; FDNY, MANHATTAN, NY**

- Oldest, most famous and most influential fire company
- Showed us photos of original doors – swing doors



## **COVENTRY FIRE DEPT, HARTFORD, CT**

- New construction wanted to modernize their operations yet honor the quaint and longstanding history of the area
- All the benefits of modern innovation and processes with respect for the flavor of historic Hartford

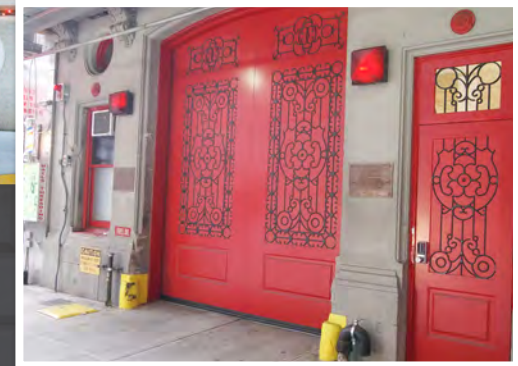

## **ENG 65; FDNY, MANHATTAN, NY**

- Original command center for all events in Times Square – built in 1895
- Original doors were matching swing doors and an entry door. We reconstructed it into a sectional overhead door with man-made door to match the original

## **OTHER COMMERCIAL DOOR PRODUCTS AVAILABLE**

From **AC-50 Doors** to **ISO Doors** to **Steel Doors**, Fimbel has you covered. For more information on our commercial offerings, please visit [www.fimbelads.com/commercial-collection](http://www.fimbelads.com/commercial-collection).



**FIMBEL**  
ARCHITECTURAL DOORS  
More in a Garage Door Since 1924.

# Custom Doors | *Some of Our Favorite Projects*



## CUSTOM DOOR 1: **2019 This Old House Idea House; New Canaan, CT**

► **Product: Custom Roaring Twenties**

The 2019 Idea House featured the restoration of the facade of an 1880s Greek Revival. Karp Associates and CAH Architects married old with new to accommodate the legacy of the home and allow for modern aspirations. To complement the restored window sashes on the front of the home, the Charleston design was chosen for the style, size and complementing interior grille.



## CUSTOM DOOR 2: **Historic Engine 55, Fire Dept. of New York, NY**

► **Product: Custom Presidential**

Engine 55's beautiful three-story firehouse, built in 1889, was designed by R.H. Robertson. The original doors were wooden swing-out carriage doors - intricately made and adorned with wrought iron. To match the original spec, as required by landmarks, a combination of innovative technology, advanced materials, craftsmanship and artistry was required.



## CUSTOM DOOR 3: **Wavehaus; Northport, NY by Charles D'Allesio**

► **Product: Custom 17' x 6" Euro-Dor**

The architect, who built the structure with a nautical theme, curving fiberglass and masonry sides, along with a wall of glass facing the Long Island Sound, says he likes to think of it as a giant suspended wave. He wanted the durability of nature with the comforts of home, and its seashell-like strength was demonstrated during superstorm Sandy.

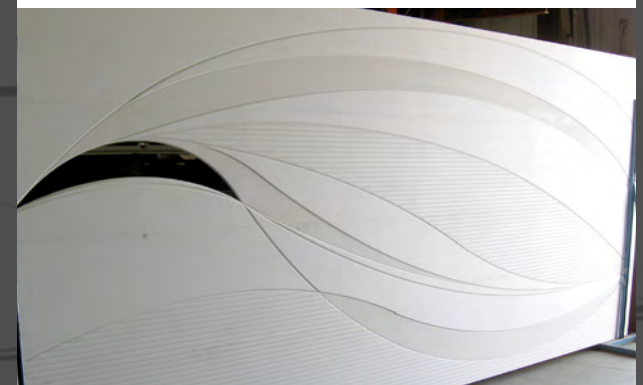

# YOU DREAM IT. WE BUILD IT!



## CUSTOM DOOR 4: **Waterside Home; Westerly, RI**

### ► Product: **American Legends**

Living on the shores of Rhode Island, this homeowner saw a neighbor's home using lattice to create a wall to enclose the parking area for their vehicles and boats. He loved the idea but wanted something more durable – more beautiful – more transitional. Tapping our capabilities; we used the American Legends Platform and added ¾" Versatex in a lattice design.



## CUSTOM DOOR 5: **Modern Design, Long Island, NY**

### ► Product: **Custom Euro-Dor**

For this project, the homeowner wanted to replace the standard garage door with a modern complement to the home's architectural design. Using our Liberty Collection platform, we reorganized the window layout and had a custom stain applied. The result is the look of individual planks of wood compiled into a four-section overhead door.

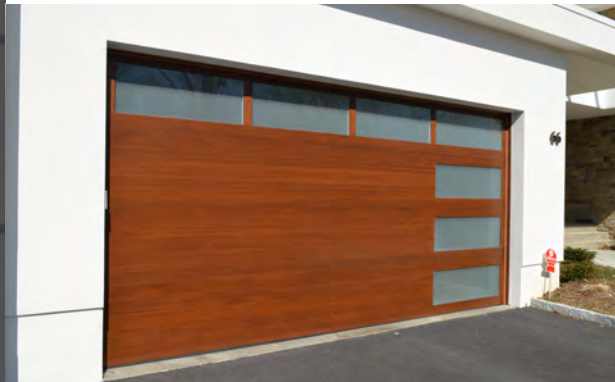

## CUSTOM DOOR 6: **Cleo's Coastal Retreat, Jamestown, RI**

### ► Product: **Half Door - American Legends Garage Doors (3) - Roaring Twenties**

Tucked into the coastal town of Jamestown, Rhode Island, this adorable retreat features sprawling views of the water's edge while offering poolside service through the half-door on the pool house. The home's garage hides toys, allowing the owners to enjoy the vast scenery.





# Finishing Options

Using heat-reflective high-performance finish, all Factory Finished products will be delivered with a clean finish to last! While most of our products do not require finishing and may remain natural white, adding color to your project can add the wow-factor that you are after!

Our vast and ever-expanding color palate includes blacks, charcoals and dark greens as well as faux stains to truly replicate the look of wood without the maintenance. With solutions for replacement of damaged sections to navigating tough exposures, we are sure our finishing options will brighten up your home and increase durability.



RT16A w/ two-tone factory finish



RT11A w/ faux stain



LV13S w/ Essex Green factory finish

## FINISHING WARRANTY:

- › Robust coverage for adhesion, cracking, peeling and reasonable fading
- › This product can be refinished as time and trends roll on
- › For more details, visit our website at [www.fimbelads.com](http://www.fimbelads.com)

## COLOR AND FINISH OPTIONS:

- › Custom solid color matching
- › Two-tone finishing
- › Custom stain matching
- › DIY in select colors
- › And more!



# Why Fimbel Finishing?

- ▶ Artisan crafted and every detail perfected
- ▶ Architectural coating with a cabinet finish
- ▶ Dark colors in tough exposures? No problem with Tricoya and our proprietary finish system
- ▶ Multilayer process for strongest adhesion
- ▶ Environmentally friendly
- ▶ See also AquaSur Tech (pg. 31)

## ARTIST'S CORNER:

- > Mixing science and artistry, we treat every project with passion and creativity.
- > Custom is, by definition, breaking the rules. Understanding how the materials work together allows us to bring to life unimaginable quality and sustainability.
- > "We have never met a stain we cannot match."

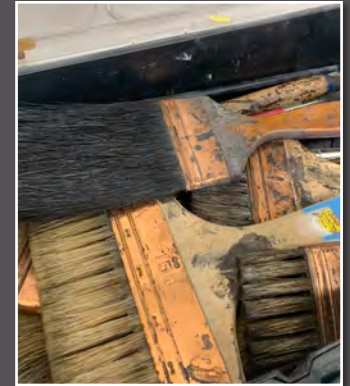

## > CHOOSE FROM OUR WIDE SELECTION OF STAIN FINISHES TO MAKE YOUR NEW DOOR STAND OUT:

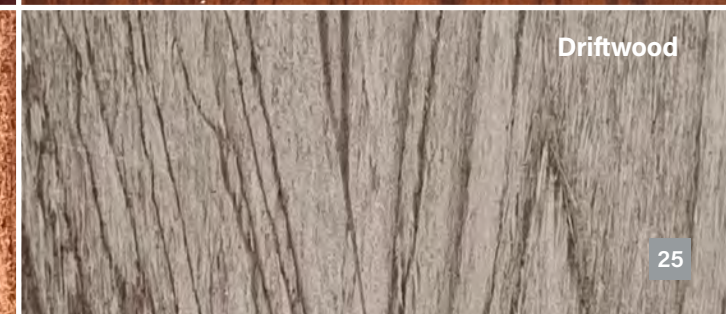
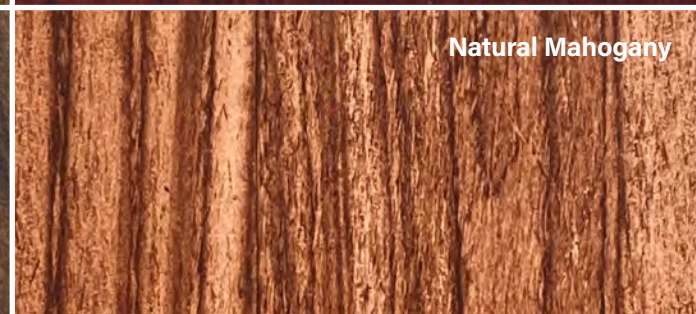
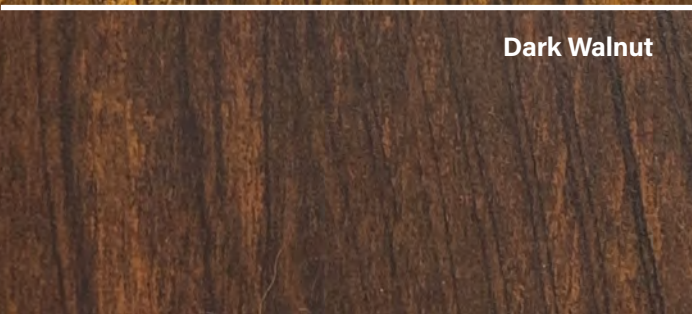
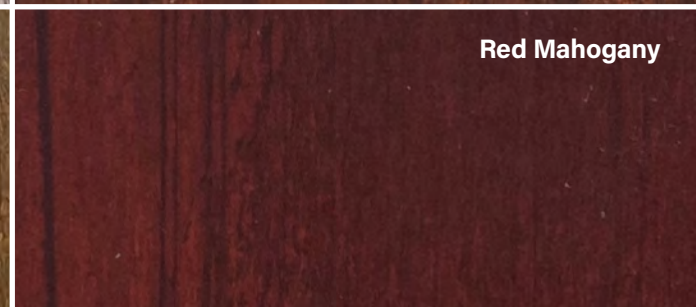
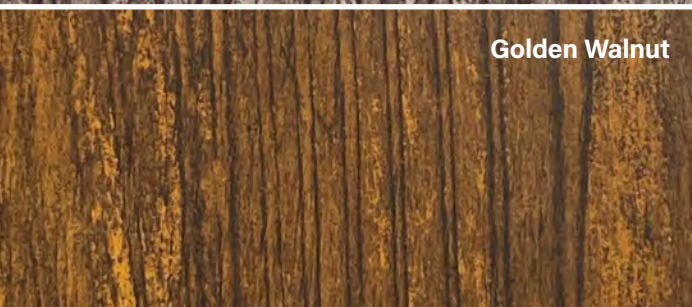
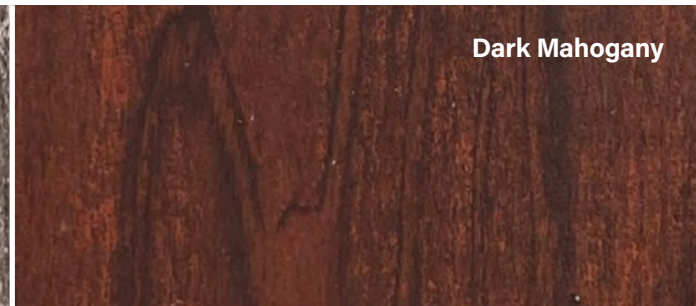



**FIMBEL**  
ARCHITECTURAL DOORS  
More in a Garage Door Since 1924

# Specialty Glass *Options*

Make it your own by choosing specialty glass for your garage door. With these options and many more, you can add style and details to your project while managing your privacy and the natural light you let in!



Custom Presidential w/ Prism Style Glass

## GLASS STYLE OPTIONS

- |   |                          |   |
|---|--------------------------|---|
| ▶ <b>STANDARD DSB</b>                   | ▶ <b>SEEDY</b>           | <i>Insulated glass comes in the following styles:</i> |
| ▶ <b>PRISM</b>                          | ▶ <b>TEMPERED</b>        |   |
| ▶ <b>PATTERN 62 OBSCURE</b>             | ▶ <b>ACID-ETCHED</b>     |   |
| ▶ <b>TINTED DBS</b><br>(Grey or Bronze) | ▶ <b>LAMINATED GLASS</b> |   |
|   |                          |   |

## INSULATED GLASS PACKAGE

Improve your energy efficiency and avoid condensation with our Insulated Glass Package to keep heat in during the winter and keep heat out during warmer temperatures.

Managing the temperature in your garage reduces the demands on your home's heating system and finances. It also reduces condensation in a temperature-controlled garage.

### PACKAGE INCLUDES:

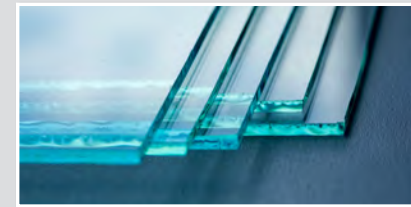

Insulated glass



Struts

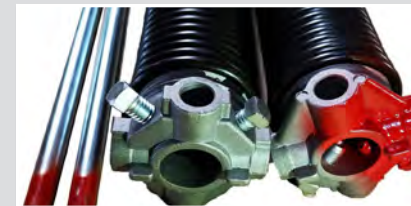

Springs

▶ **NOTE:** Not an upgrade - required in specific conditions.

# Even More for Your Door...

## DECORATIVE HARDWARE

For a true carriage look, we offer a variety of options for decorative hardware. From strap hinges and pull handles to latches and clavos, you can further customize your door! *Many standard kits are available, but the options are limitless!*



Custom Presidential w/ Clavos and Cadet Grey Factory Finish

► **Colors Available:** Black Dark Earth, Oil Rubbed Bronze, Satin Nickel and Copper.

For more decorative hardware, visit our partners, Re-Source Industries, at: [www.re-sourceind.com](http://www.re-sourceind.com)



## WIND LOAD PACKAGE



Fimbel Wind Load approved garage doors offer your home protection during extreme wind conditions. Through rigorous testing over the years to determine wind load eligibility, we continue to optimize our product to bring you the highest quality and safety you can count on.

## ADDITIONAL OPTIONS



Hi-Lift



Longer Life Springs



Powder Coated



Interior Grille\*

*\*Only available on the Estate Collection*



3/8" Vinyl Interior Backer



**FIMBEL**  
ARCHITECTURAL DOORS  
More in a Garage Door Since 1924.

# Glazed Grille Top Options

Design your own, or count on one of ours! Customize to meet your needs. Solid tops available, see website for further options: [www.fimbelads.com](http://www.fimbelads.com).

## STYLE

**Traditional:** 1" Vertical Muntins across whole grille: arch or square

**Standard on:** AL, PR, RT **Available on:** All Series



**Euro:** 3 1/2" Vertical Muntins in center of bay: arch or square

**Standard on:** EU **Available on:** All Series



## DESIGN - You dream it. We build it.

**SINGLE ARCH**



**DOUBLE ARCH**



**COLONIAL**



**RECTANGLE LITES**



**CUSTOM MODERN**



**CUSTOM**



**SCROLL**



**CUSTOM ELLIPTICAL AND TEMPLATE ARCH**



## PROFILE

**C-Grille:** Bead with Radiused Inside Corners

**Standard on:** EU, PR, AL  
**Available on:** All Series

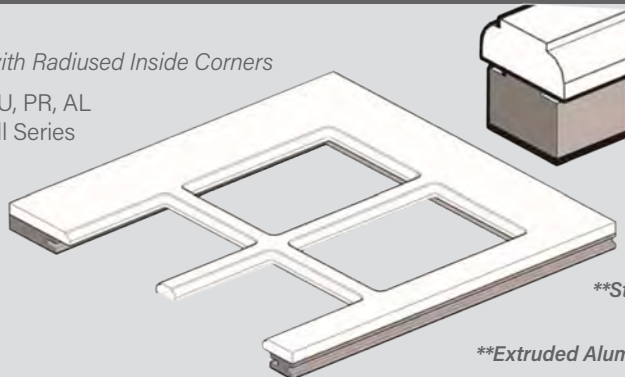

**V-Grille:** Putty Bar with Sharp Inside Corners

**Standard on:** RT, RP  
**Available on:** All Series

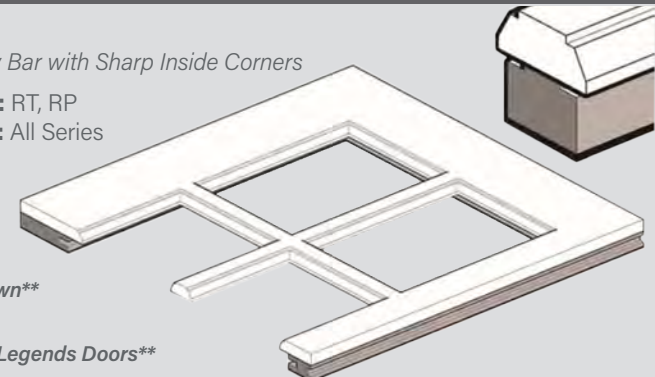

**\*\*Standard Wood Grille Frame Shown\*\***

**\*\*TDL Grille Frame Available\*\***

**\*\*Extruded Aluminum frame used on American Legends Doors\*\***

# Trust & Value

We hang our hat on safety and quality at Fimbel Architectural Doors. When our doors welcome you home, we will be standing behind the quality and satisfaction you will feel.

## > WARRANTY:



**Limited Lifetime Warranty\***

*\*Consult your dealer for details*



**1 Year: Hardware**



**15 Years: Sections**



**Finish Warranty:**

- Paint - 15 Year
- Stain - 5 Year

## > CUSTOMER SERVICE:

From design challenges to construction constraints, if you have any questions, please reach out to our customer service team at [sales@fimbelads.com](mailto:sales@fimbelads.com).

*We look forward to working with you!*



## > SAMPLES TO YOUR DOOR:

Contact your authorized dealer to request a sample of not only our sections but also our factory finish offerings.

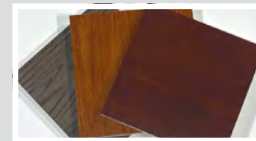

## > CARE AND MAINTENANCE: For comprehensive instructions, please visit [www.fimbelads.com](http://www.fimbelads.com)

### For general cleaning of Fimbel garage door sections:

- ▶ Rinse dust and debris from the face of the door using warm water
- ▶ Use warm water and a mild dishwashing liquid soap using a wet sponge on the sections
- ▶ Rinse thoroughly with warm water

### For more stubborn spots on white, unfinished doors:

- ▶ Soft Scrub, Clorox Cleanup or Clorox Outdoors can be used
- ▶ Use Mr. Clean Erasers with a gentle hand
- ▶ Wipe with isopropyl or denatured alcohol to remove any soap, cleaner residue or dust

### For factory finished doors:

- ▶ If you have any questions or concerns regarding your finish, please contact your dealer before proceeding
- ▶ DO NOT ATTEMPT TO CLEAN THE FINISH FOR AT LEAST 30 DAYS AFTER INSTALLATION TO ALLOW TIME TO FULLY CURE



**FIND AN AUTHORIZED FIMBEL DEALER NEAR YOU TO BRING YOUR PERFECT DOOR TO LIFE.**

For 95 years we have worked with dedicated and talented men and women to provide you with excellent service, and we carry that tradition forward today. Visit our website to find a dealer [www.fimbelads.com/dealers](http://www.fimbelads.com/dealers), or email our Customer Service Team at [sales@fimbelads.com](mailto:sales@fimbelads.com) to learn more!



**FIMBEL**  
ARCHITECTURAL DOORS  
More in a Garage Door Since 1924.

# Architects

Whether you find inspiration in nature, the neighborhood or the newest concept, our goal is to offer solutions to bring your vision to life while offering beauty and durability you can count on. For more inspiration, visit us at: [www.fimbelads.com](http://www.fimbelads.com)

## AMERICAN LEGENDS DOOR DETAILS

**Construction:** Solid grille and overlays, vinyl-coated steel face, painted aluminum glass section frame and powder coated steel end and center stiles

**Available Heights:** Any size in 1" increments

**Available Widths:** 8', 9', 10', 16' and 18'

**Thickness (whole section):** 2 1/2"

**Overlay thickness:** 3/8"

**R-Value:** 13.12

**Top:** Simulated Divided Lites with a C-Profile or V-Profile available

**Fastening Points:** White powder coated steel end and center stiles

**Section Joints:** Interlocking tongue & groove vinyl-coated steel

**Interior Face:** High impact pre-finished white interior cover

**Exterior Face:** 20 gauge vinyl-coated face with solid PVC overlays

**Heavy Duty Bottom Astragal:** Seals the bottom of the door and keeps water and debris from coming under the door  
Our heavy-duty astragal lasts longer

## ESTATE COLLECTION DOOR DETAILS

**Construction:** Wood core, Polystyrene insulation, Solid face, Solid-Seal edge banding, Inlaid Overlays (Roaring Twenties Only)

**Available Heights:** Any size in 1" increments

**Available Widths:** Any size in 1" increments

**Thickness:** 1 7/16" (Euro), 1 3/4" (Presidential), and 1 13/16" (Roaring Twenties)

**R-Value:** 8.12 (Euro), 9.5 (Presidential) and 9.12 (Roaring Twenties)

**Top:** Simulated Divided Lites with a C-Profile or V-Profile available

**Fastening Points:** Heavy duty wood frame made of kiln-dried pine at all hardware fastening points

**Section Joints:** Interlocking vinyl tongue & groove

**Interior Face:** High-impact, pre-finished white interior cover

**Exterior Face:** Solid single sheet

**V-Groove Spacing:** 5" on center (available in all models)

**Bead Board Spacing:** 3 1/8" on center (available in Euro and RT - Presidential excluded)

**Heavy Duty Bottom Astragal:** Seals the bottom of the door and keeps water and debris from coming under the door  
Our heavy-duty astragal lasts longer



### OVERLAY DIMENSIONS:

- ▶ All standard doors have these dimensions
- ▶ All Estate Collection products can be customized

### DIMENSIONS:

- End Stiles 4.75"
- Center Stiles 9.5"

- Intermediate Stiles 3.5"
- Bottom Rail 6.5"
- Meeting Rail 2.375"

- Horizontal Rail 4.75"
- Top Rail 5.125"
- Radius TBD based on width



## WHAT TO MEASURE FOR GARAGE DOOR SPECS:

- 1) Measure the opening width and height using feet and inches to determine the size of the door required. Be sure the floor and opening are complete prior to measuring.  
*Note: not all openings are level, but we have solutions!*
- 2) Measure the sideroom of the door.
- 3) Measure the headroom of the door and be sure to note obstructions. This distance measures the space above the door opening and the ceiling.
- 4) Measure the backroom of the garage noting any obstructions.

# Building Materials & Partnerships

Our material selections are made with great care and scrutiny as we have learned how important it is to make the choice based on safety and quality. The three suppliers below have impressed us with their products, sustainability and partnership. We are proud to showcase them for you!



**VERSATEX**  
BUILDING PRODUCTS

VERSATEX is a free-foamed cellular PVC material that duplicates the beauty of wood, yet provides long lasting protection against rot, cracking and decay—all without requiring any paints or sealants to protect it from the environment.

Unlike wood, VERSATEX Trimboard is impervious to moisture, insect-resistant and will not rot, rust or corrode. VERSATEX requires less maintenance than wood, wood composites or fiber cement trims and does not require painting for protection.

VERSATEX is an ideal solution for moisture sensitive areas, including those along coastal zones or regions affected by salt and high humidity.

VERSATEX carries a lifetime transferable warranty against cracking, cupping, rot, decay or any possible defect you would face with wood. VERSATEX features a lifetime warranty that is fully-transferable.



**AquaSurTech**  
OEM

D200 is a high-performance single application exterior water-based coating system designed for direct application to PVC.

We have developed a custom process for application of this premier coating to Tricoya. The result is superior.

Excellent adhesion, abrasion resistance and impact resistance.

D200 is formulated with heat reflective pigments to minimize head gain for dark colors and is considered non-hazardous by EPA standards.

D200 exceeds all environmental and performance standards (meets AAMA 615).

As close to a furniture-quality finish on an exterior product as you can find.

Warranty to protect against peeling, blistering or fading providing a service life of 20+ years.



**tricoya**

Tricoya is a high-performance MDF panel characterized by its durable and dimensional stability properties yet requires no supplemental protection or finishing even when exposed to moisture.

Using proprietary acetylated wood technology and a modified MDF manufacturing process, Tricoya solves the issue of water-absorption causing swelling.

Tricoya is durable: Longer lasting, perfect for outdoor use even in wet environments making it dimensionally stable to reduce swelling and shrinking.

Environmentally-friendly: no added formaldehyde and sustainably sourced (FSC Certified).

Warranty offered for peace of mind for 50 years.

**CHALLENGE WHAT YOU THINK IS TRUE OF GARAGE DOORS! WE DARE YOU!**

For 95 years, we have worked with dedicated and talented men and women to provide you with excellent service, and we carry that tradition forward today.

Visit our website to find a dealer [www.fimbelads.com/dealers](http://www.fimbelads.com/dealers), or email our Customer Service Team at [sales@fimbelads.com](mailto:sales@fimbelads.com) to learn more!

# *Experience More...*

More Creativity. More Beauty. More Durability.



FROM STANDARD TO CUSTOM SOLUTIONS, ANYTHING IS POSSIBLE.

## *Certifications, Partnerships, Associations & Recognition*



More in a Garage Door Since 1924.

Fimbel Architectural Door Specialties

PO Box 96, Whitehouse, NJ 08888

908.534.1732

sales@fimbelads.com

fimbelads.com

